

Operating & Maintenance Guide



somfy®

Rollixo Control Unit



July 2024



Contents

Welcome To SeceuroGlide	Page 3
Register Your Warranty	Page 3
Looking After Your Garage Door	Page 4
Operating Instructions	Page 5
Remotes	Page 6
Safety	Page 7
Power Failure	Page 7
– Electrically Operated Products	
Manually Operated Products	Page 7
Trouble Shooting	Page 8
– Electrically Operated Products	
– Manually Operated Products	
Service & Maintenance Record	Page 9
Declaration of Conformity	Page 12

To ensure compliance with the Machinery Directive this document must be given to the owner of the door and held for future reference.

Date of installation:	
Installation by:	
Product type:	SeceuroGlide Original <input type="checkbox"/> SeceuroGlide Excel <input type="checkbox"/> SeceuroGlide Compact <input type="checkbox"/> SeceuroGlide LT <input type="checkbox"/> SeceuroGlide Manual <input type="checkbox"/>
Contact details:	



SeceuroGlide Original
Graphite Finish

Welcome to SeceuroGlide



Thank you for your recent purchase of a SeceuroGlide Roller Garage Door.

Combining great design and exceptional build quality the SeceuroGlide roller garage door you have purchased has been designed and manufactured in the UK and offers attractive, effortless protection for your home.

We understand that the purchasing of your SeceuroGlide Roller Garage Door is a significant investment for you and your property. This has led us to putting together this small guide to allow you to get to know your garage door better.

Your newly installed product should give you many years of trouble free service as it is designed to require minimal maintenance and servicing. In order to prolong the life of your door and to reduce the likelihood of problems please adhere to the following instructions. Please note all products should only be operated by trained users.

Wishing you many happy years with your new purchase.

The SeceuroGlide Team



REGISTER NOW

Activate your **FREE 7-Year Warranty***

Your SeceuroGlide Roller Garage Door comes with a 5-year parts only guarantee*, which covers you against defect of material or workmanship by SWS UK, subject to correct installation, maintenance and operation.

Where supplied together, the Somfy motor and Rollixo control unit come with an extended **7-year warranty**, subject to registration within 3 months of installation.* Foiled woodgrain doors are guaranteed on the slat finish only for 10 years.

To register please visit www.seceuroglide.co.uk

*Terms and conditions apply, see website for details. 7-year warranty is not valid on LT garage doors.



SeceuroGlide Excel
White Finish

Looking after Your Garage Door

Tips on maintenance for your new SeceuroGlide Garage Door.

Your garage door is low maintenance:

- ✓ The curtain needs wiping with a damp cloth and a mild detergent to remove any excessive dirt/grime to maintain its appearance and to reduce the risk of the surface being damaged.
- ✓ This must be done more frequently in a salt air environment.
- ✓ Marks on the paint finish can be cleaned with many types of car polish.
- ✓ Chips in the paint work should be touched up to prevent corrosion of the metal.
- ✓ The power to the garage door should be isolated before washing or repairing the paintwork.
- ✓ The motor and curtain have been designed to be lubrication free so you must not oil or grease the guide rails.
- ✓ Make sure no foreign items get collected in the guides i.e: stones, sticks, paper etc.

Additional information

for electrically operated products

Your door should run smoothly and easily as the motor is not designed to over-come problems of a badly running or damaged door. If necessary contact your approved installer for repair.

The motor should be stopping on the limits and not over-running (indicated by buzzing) when the door hits the floor or the open stops.

N.B. Always isolate the power before attempting to make any adjustments or repairs. Untrained operators are advised to contact an approved installer.

Operating Instructions

Electrically Operated Products

Whenever possible the garage door should be operated when it is in view, making sure it is not obstructed. Ensure when the curtain is running, that you and any other person stands clear of the curtain and keeps hands etc. away from the moving parts.

Control Unit

Please note the front of the control unit should only be removed by a trained engineer. Your garage door can be activated by pressing and releasing the buttons on the front of the control unit, the button on your remote handset, or a separate wall switch that you may have installed.



Rollix Control Unit

Hand Transmitters

The transmitters are fitted with one large button and three smaller buttons.

The buttons on remotes can be programmed to suit your requirements. The default setting is one button operation that allows you to lift, stop and close the door.

PLEASE NOTE

When opening or closing the garage door you must monitor the product until it has completed its operation. If the product is fitted with a safety device this could be activated during its operation which would cause the door to stop and reopen a short distance leaving the door partly open.

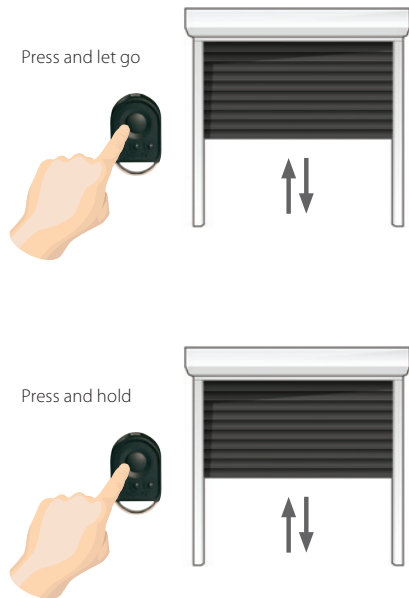



SeceuroGlide Excel
White Finish

Remotes

Your SeceuroGlide roller garage door will be supplied with two remote controls.

The Keygo Remote

The Keygo is a four channel keyring remote control. The compact design makes it ideal to keep in your pocket or bag.

Keygo



Technical information

Dimensions: 59 x 35 x 15 mm

Working temperature: -20°C – +60°C

Adding Remotes

Please note: The Keygo remote controls that come with the board are already programmed.



STEP 1

Hold the 'Prog' button on the control unit until the LED lights up red.



STEP 2

Hold the button on the Keygo remote control until the LED on the control unit flashes and then goes out.

Safety

Safety Edge

The Safety Edge is fitted to the bottom of the door and is activated when the door starts to close. If it comes into contact with an object while the door is closing, it transmits a signal to the wall mounted control unit, the door will then stop and reopen a short distance.

The safety edge also works as a weather seal, designed to be pressed against the ground. The bottom slat transmitter has an IP rating of IP54 and is protected against dust and water splashing.



Power Failure

Electrically Operated Products

If your roller garage door is not working correctly please contact your installer for assistance. **N.B:** Always isolate the power before attempting to make an adjustment or repair. Untrained operators are advised to contact an approved installer.

Power Failure

In the event of disruption to the power supply, or the motor temporarily over heating (the motor is protected by a thermal cut out), the door can be operated manually. Isolate power supply before using the manual override.

To operate: Hold crank handle in line with eye and rotate handle until the door reaches the open/closed position.

DO NOT OVERWIND

When the main power is reinstalled, ensure that the power isolator is switched back on. If applicable secure the handle back onto the wall. Remember to keep the crank handle in a convenient place.

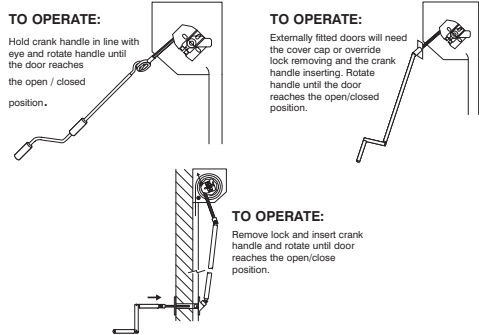

Manually Operated Products

Make sure there are no obstructions. Ensure when the curtain is running, that any other person stands clear of the curtain and keeps hands etc. away from moving parts. You will have a lock in the locking slat.

Opening the garage door





Press slightly down on the handle when the garage door is in the closed position; disengage the locking mechanism(s). Ensure the key is removed before opening the garage door. Push the garage door curtain upwards to open. Do not let go of the garage door until it has reached its open position.



































Closing the garage door

Pull the garage door down using the handle provided. When the door reaches the close position press down on the handle before engaging the locking mechanism.

Trouble Shooting

Electrically Operated Products

LED	Status	
	Off	Standby
	Slow flashing	Waiting for an input/adjustment
	Rapid flashing	Deactivation/activation in progress
	Constantly on	Installation fault/failure

Fault	LED Status					Possible Cause	Solution
							
No door movement.						Motor wired incorrectly. The motor thermal protection has activated.	Wait for the motor to cool down (10 minutes).
Waiting for motor adjustment.							Motor limit positions need setting. Please contact the installer.
Door opens OK. Door closes in dead man mode.						Optical wired safety edge failure. Radio safety edge failure.	Please contact the installer.
Door opens OK. Door closes in dead man mode.						Radio interference.	If a powerful radio system is present close by and is transmitting on the same frequency, the receiver may be experiencing radio interference. Check if any wireless systems are present within the area.
Door opens OK. Door closes in dead man mode.						The safety edge transmitter batteries have expired.	Replace the bottom slat safety edge transmitter battery.*
The door has stopped due to an obstacle.						Obstacle detection.	Check for obstacle interference with the safety edge strip or photocell.
Hand transmitter not working.						Hand transmitter batteries flat.	Change hand transmitter battery.**

Manually Operated Products

Fault	Possible Cause	Solution
Lock will not engage	The lock is not correctly aligned with the lock hole.	Apply more pressure to the bottom of the curtain until the lock engages or move the curtain around slightly until it is in the correct position for the lock(s) to engage.
Lock has become loose.	The screws holding the lock to the door have begun to unfasten.	Check and tighten the two screws fastening the lock to the door.

*Bottom slat transmitter battery is a CR2430 battery.

**Hand transmitter battery is a CR2430 battery.

Service and Maintenance Record

We recommend that your SeceuroGlide Roller Garage Door is serviced by an official SeceuroGlide distributor once every 12 months.

Should you require any assistance with your SeceuroGlide Roller Garage Door please only use an official SeceuroGlide distributor and request they fill in the below form with details of any work carried out and replacement parts fitted.

Date:			
Work carried out:			
Work performed by:			
Print:			
Signed:			
Company name:			
Notes:			

Date:			
Work carried out:			
Work performed by:			
Print:			
Signed:			
Company name:			
Notes:			

Date:			
Work carried out:			
Work performed by:			
Print:			
Signed:			
Company name:			
Notes:			

Date:			
Work carried out:			
Work performed by:			
Print:			
Signed:			
Company name:			
Notes:			

Date:			
Work carried out:			
Work performed by:			
Print:			
Signed:			
Company name:			
Notes:			

Date:			
Work carried out:			
Work performed by:			
Print:			
Signed:			
Company name:			
Notes:			

DECLARATION OF CONFORMITY



No. 0087 CPR 07-2013

SWS UK Head Office: Hornby Road, Claughton, Lancaster LA2 9LA

A StellaGroup Company

PRODUCT NAME: SeceuroGlide Roller Garage Door

IDENTIFICATION NUMBER: SeceuroGlide P25

The company above declares under its own authority that the door above is fully compliant with:

- Supply of Machinery Safety Regulations 2008

The company additionally declares that the door is in compliance with the following directives:

- 2014/30/EU – Electro-Magnetic Compatibility Directive (EMC)
- 2014/53/EC – Radio Equipment Directive (RED)
- EN 13241:2003 + A2:2016

Signed for and on behalf of the manufacturer by:

NAME: Colin Reoch (Managing Director)

DATE: 22nd May 2023

SIGNED:

Your local distributor is:



Raising Standards
Safety Assured



Assessed to ISO 9001 & ISO 14001
Cert/LPCB ref. 390